

# Beale Street Audio

**TIC651, TIC801** In Ceiling Speakers

**TICW401** In Ceiling/In Wall Shallow Depth

**TU401** In Ceiling/In Wall Pancake

25/70/100V Speakers

## Installation Guide



Get Reale. Get Beale.™

# Introduction

Congratulations and thank you for purchasing Beale Street Audio 70 Volt In Ceiling/In Wall speakers with Sonic Vortex®.

Our patented Sonic Vortex Technology is based on Ported Transmission Line design and incorporates a compact, integrated enclosure. Most In Ceiling speakers do not utilize a back box, even fewer have an enclosure, and only a Sonic Vortex speaker has an Integrated Transmission Line Ported Enclosure. Without something behind the speaker driver the music not only plays into the room, but also bleeds into adjoining rooms such as the attic or an occupied room. The bleed negatively affects performance, and sound consistency.

The Sonic Vortex enclosure directs all of the sound from the speaker driver into the room it is intend to be in, so you get to enjoy your speakers without disturbing the rest of the house. Great bass response, stereo image, and big sound that you can't get with any other in ceiling speaker.

Beale Street Audio 70V speakers install with ease using the 'dog' mounting system and magnetic bezelless grilles for fast, clean installations.

The TIC and TU series 25/70/100 volt Beale Street Audio speakers offer exceptional performance in a 70/100V system. Beale Street Audio 70/100V speakers with Sonic Vortex really help improve overall performance and sound quality in 70/100V systems where audio quality is sometimes not the main focus.

Please follow the instructions in this manual to assure proper installation and to achieve the full performance and satisfaction you would expect from Beale Street Audio.

# Speaker Placement

When installing in wall/in ceiling speakers, (or in wall/in ceiling anything for that matter) it is always a good idea to find out what is in the wall/ceiling before cutting holes. Be aware of the location of plumbing, electrical and structural elements that may affect speaker placement.

## **Stereo**

It is also a good idea to locate stereo speakers so they are centered to the main listening position in which the user/s will normally be located. Whenever possible, try to position the left and right speakers at the same distance from each other as they are from the main listening position.

## **Subwoofer**

Subwoofers are omni-directional so placement of in wall/in ceiling subs is somewhat less critical, but placement can be affected (good and bad) by corners and walls, so try to find a location that will be somewhat unaffected by placement.

## **Angled**

If using the 'Angled In' speakers, be sure to position them so the speakers are facing into the room and directed toward the main listening position.

## **Surround**

Locate surround speakers according to the recommendations in the surround processor's owner's manual.

# Installation

## **SPEAKER WIRE - 25/70/100V**

When pulling wire for a 70V/100V speaker system, pull distribution lines (each distribution line is a wire pair) in a daisy-chain pattern, (amp to first speaker, first speaker to second speaker, second speaker to third speaker, etc). If distributing stereo, pull individual distribution lines to each speaker location for each pair (left/right) in a daisy chain from the amp location. Use quality stranded speaker wire based upon the 70V Speaker Wire Gauge Table below.

<b>70V SPEAKER WIRE GAUGE (30W Zone Output)</b>	
<b>SPEAKER WIRE LENGTH</b>	<b>SPEAKER WIRE GAUGE</b>
<b>350' (106m)</b>	<b>24 AWG</b>
<b>550' (167m)</b>	<b>22 AWG</b>
<b>900' (274m)</b>	<b>20 AWG</b>
<b>1400' (426m)</b>	<b>18AWG</b>
<b>2300' (701m)</b>	<b>16AWG</b>

## **NEW CONSTRUCTION**

Beale Street Audio speaker installation can be simplified by using a Beale Street Audio new construction EZBracket®, (sold separately; visit [www.getbeale.com](http://www.getbeale.com) for additional information). This is installed prior to drywall installation and allows for precise speaker placement and simplifies the final installation of the speaker.

## **EXISTING CONSTRUCTION**

70/100V distribution lines must be run in a daisy chain configuration from the amplifier to the first speaker location then to the second speaker location and so on.

- Choose a location for each speaker that is free of obstructions created by joists, HVAC duct-work, electrical wire runs, plumbing or anything else that might not allow for the depth of the speaker or create interference or noise.

# Installation

- Once you have determined your locations, use a pencil to mark the hole to cut out for the speaker using the supplied template. Don't forget to allow for the size of the speaker bezel if you are installing the speaker near a sidewall or other item that could become an obstacle.  
NOTE: Round grille and square grille finish both use the same drywall cutout.

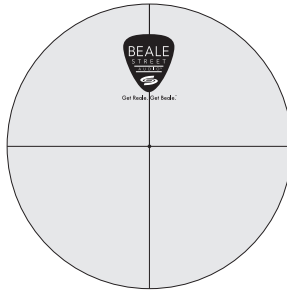

- If you are unsure of potential obstacles, carefully cut your holes using an angle cut to the inside of the cutout area. This will allow you to “plug” the hole easily if needed. If the area is clear and is a good location for the speaker, go ahead and cut the edges of the opening at 90 degrees to accommodate the speaker diameter.

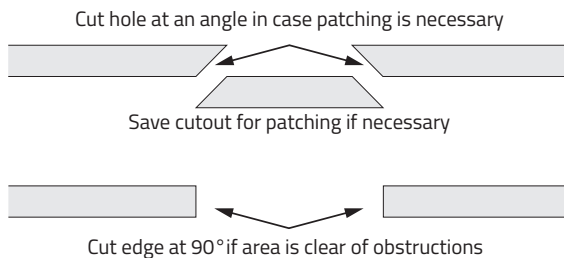

- Strip the insulation on each conductor approximately 1/2" (12.7mm) and insert to the plug in speaker terminals. Ensure that there are no stray strands of wire protruding from the connectors that can cause shorts. Observe proper polarity (+ to + and – to –) for each speaker and at the amplifier. Be sure to tighten the ‘elevators’ on the plug in connector so the wires do not come loose after installation.

# Installation

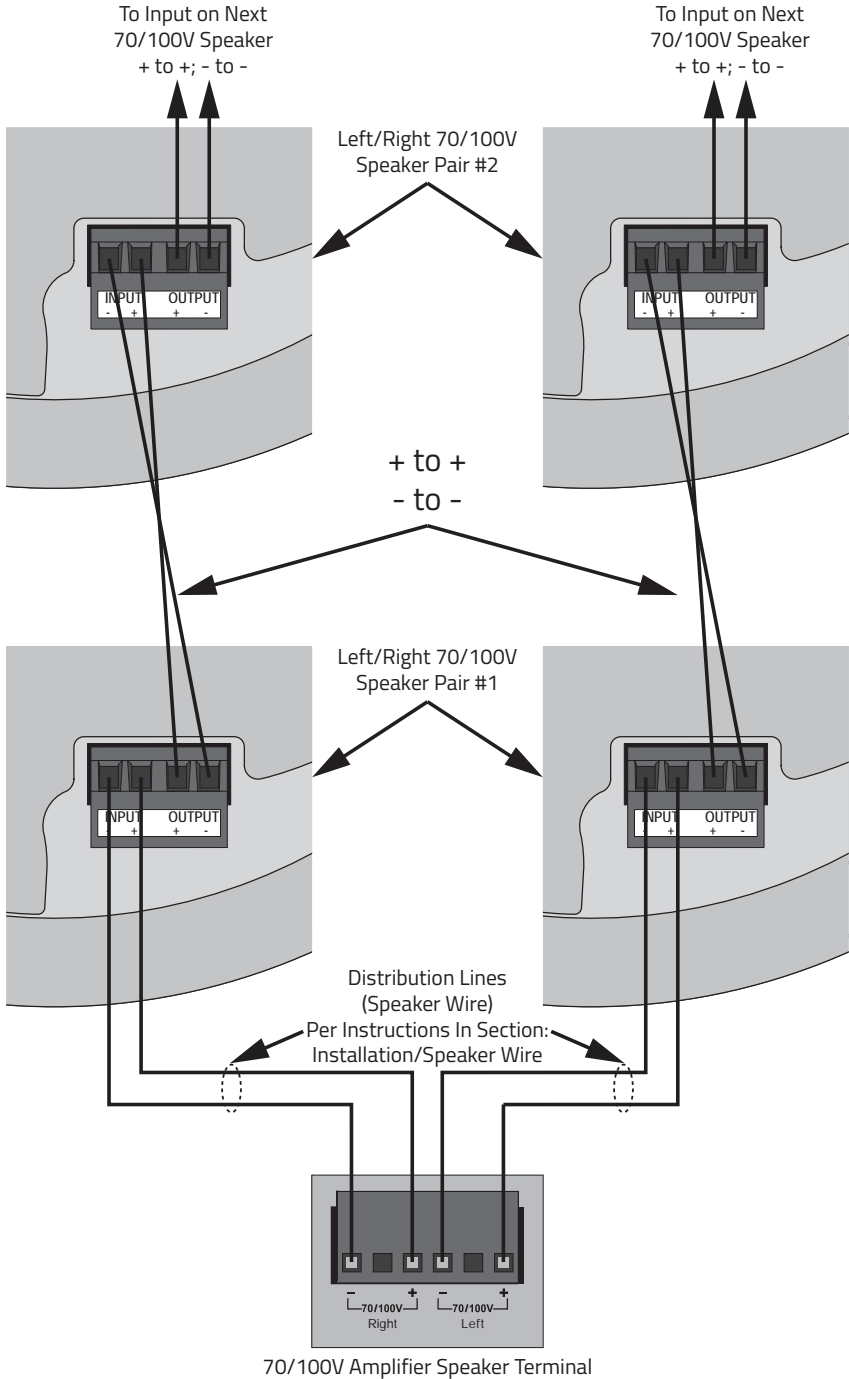

# Installation

## TAP WATTAGE

In a 70/100V system it is necessary to select tap wattage to determine amplifier power requirements and set relative speaker volume.

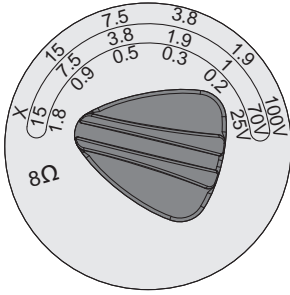

TICW401/TU401 Tap

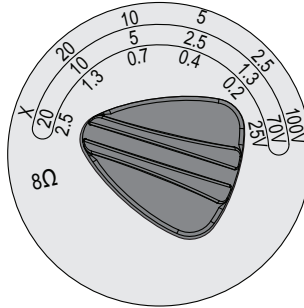

TIC651 Tap

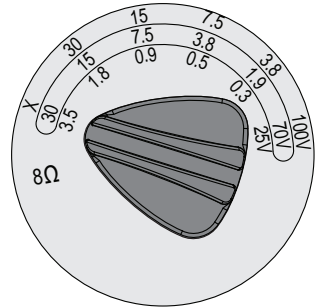

TIC801 Tap

Note the different tap settings by model.

Use the gauge on the tap that corresponds to the distribution line voltage used for the system being configured (25V, 70V, 100V).

Add up the total tap wattage set for all of the speakers to be connected to a 70V/100V zone and multiply by 1.2. This will provide sufficient power to compensate for an efficiency loss of around 20% that is typical in 70/100V systems.

## **8Ω**

If a low impedance amplifier is going to be used, be sure to set the speaker Tap Selector to 8Ω, and connect the amplifier speaker terminal +/- to the INPUT +/- on one 8Ω speaker. If the amp is capable of a low impedance load, (4Ω/2Ω) and if the speaker load is acceptable, (two 8Ω speakers, one 4Ω speaker, etc) connect the speaker(s) to the amp in **parallel**, (all speakers' + to amp +, all speakers' - to amp -) **not daisy chain** as used for 70/100V. If you're not sure about an amplifier's load handling capability, contact the amplifier manufacturer's technical support for assistance to avoid potential major damage to the amp and speakers.

# Installation

## Round Grille

- With the 'dogs' flush to the side of the speaker, insert the speaker into the cutout and tighten each of the four screws for the speaker's dogs, enough to clamp the speaker to the drywall. Do not over-tighten.

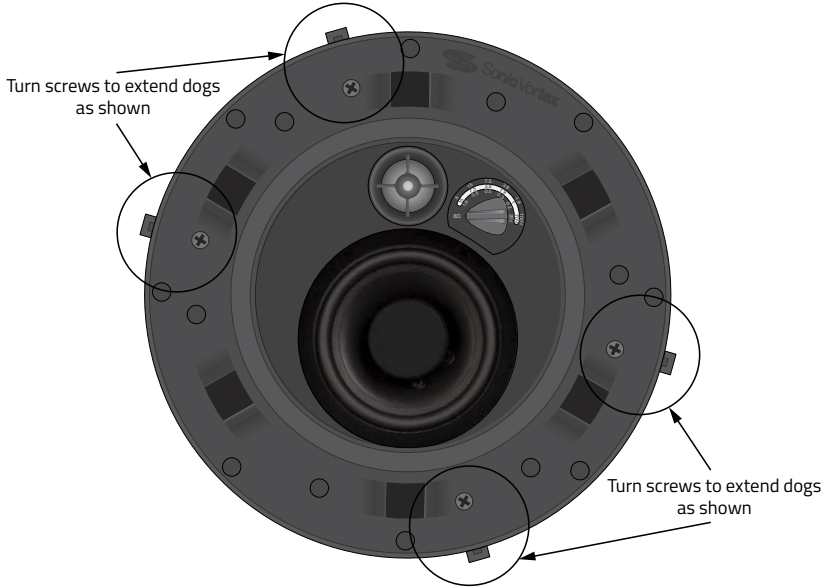

- Attach the round grille to speaker. The grille attaches with magnets so it will just snap into place.



# Installation

## TU401 ORIENTATION

For best results in a stereo application when using TU401 speakers, be sure to install the left and right speakers symmetrically so the woofers and tweeters are oriented as mirror images as shown below. This will improve stereo imaging and overall audio performance. Orienting the woofers and tweeters in random positions will result in less than ideal performance.

### **DO THIS: (Tweeters Vertical)**



### **OR THIS: (Tweeters Horizontal)**

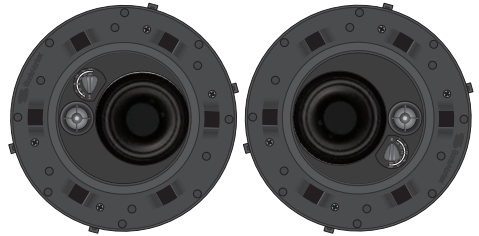

### **DO NOT DO THIS: (Tweeters in Random Positions)**

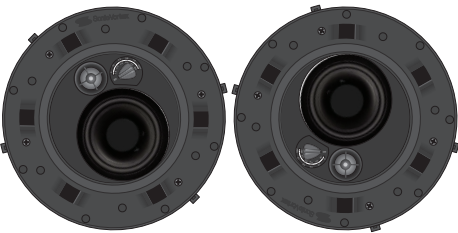

# Installation

## Square Grille (Models TIC651, TICW401)

Optional square bezels/grilles are available separately. Please reference Beale Street Audio part numbers: 4" - GS4W, (white) GS4B (black); 6.5" - GS6.5W, (white) GS6.5B (black) when ordering.

- With the 'dogs' flush to the side of the speaker, insert the speaker into the square bezel as shown.

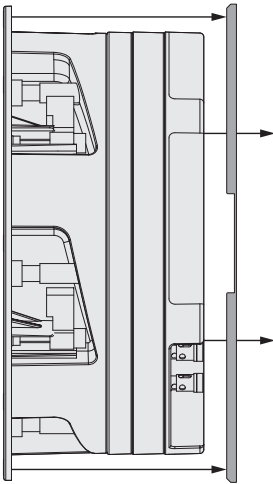

1. Slide the Speaker into the Square Bezel

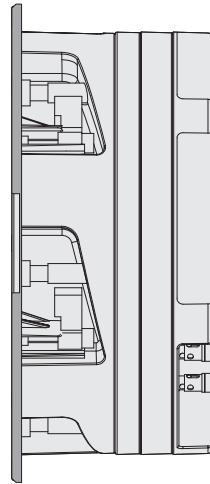

2. Assembled Speaker and Square Bezel

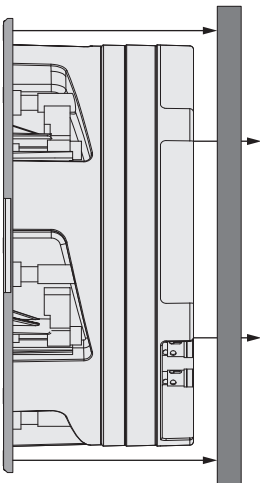

3. Slide the Speaker/Square Bezel into the Drywall Cutout

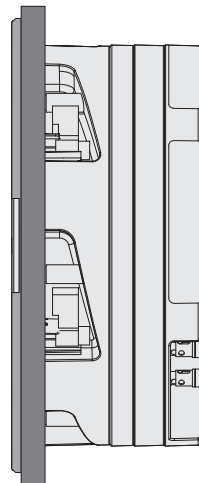

4. Installed Speaker and Square Bezel

# Installation

- With the speaker/bezel assembly installed in the wall, using a level, square the bezel to the wall and then turn the 'dog screws' to secure the speaker and bezel to the drywall.

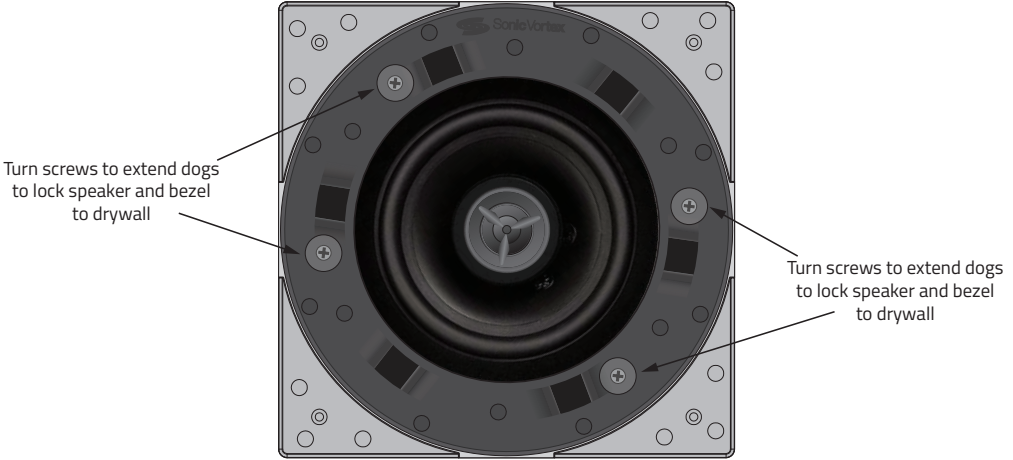

- Attach square grille to bezel. The grille attaches with magnets so it will just snap into place.

## Adapting the Square Grille to an installed Round Speaker

- You can adapt the square bezel/grille to an installed round speaker by cutting one of the thin sides of the bezel, loosening the dogs on the installed speaker just enough to create a space between the speaker and drywall and then slipping the bezel around the speaker. Square the bezel to the wall and then tighten the 'dog screws' to secure the speaker and bezel to the drywall. Install the square grille.

## Pivoting Tweeter (TIC651, TIC801, TICW401)

- With the speaker installed, the tweeter can be pivoted to point directly into the main listening area for tighter imaging of high frequency content. Pointing the tweeter away from the main listening area will create a more ambient sound.

Carefully press the edge of the tweeter as shown to pivot the tweeter to the desired position.

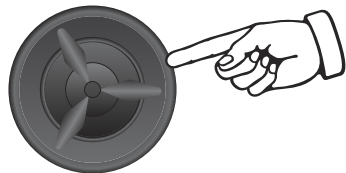

# Installation

## **PAINTING**

The grille can be painted, but go as light as possible to not to clog the fine holes with paint. Only paint grilles when they have been removed from the speakers and be sure to remove the cloth on the backside of the grille before painting. If the cloth is not removed for painting, it will absorb the paint and clog the grille, significantly affecting the sound...and not in a good way. (We have taken great effort to eliminate any 'color' from the sound of our speakers, so let's try to keep it that way...OK?)

## **TROUBLESHOOTING**

Beale Street Audio speakers are designed to function trouble-free. Most problems that occur are due to simple issues. If you have trouble, please check the list of simple fixes below.

<b>SPEAKER TROUBLESHOOTING</b>	
<b>PROBLEM</b>	<b>SOLUTION</b>
NO SOUND	Verify that there is audio from the source selected. Select another source if necessary.
	Ensure that the amplifier is turned on and connected properly.
	Check any connections at other devices, such as a volume control. Temporarily bypass the control if needed.
	Check wire connections at each speaker not producing sound for good contact to bare wire, not wire insulation.

# Specifications

## 6.5" IN CEILING

### **TIC651 70/100 Volt In Ceiling 6.5" 2 Way**

- In Ceiling 2 Way
- Woofer: 6.5" Fluted Injected Poly
- 1" Aluminum Dome Tweeter
- Butyl Rubber Surround
- Sonic Vortex® Ported Transmission Line
- Magnetic Bezelless Grille; White - Paintable
- Low Impedance: 8Ω
- 25V 0.2, 0.4, 0.7, 1.3, 2.5
- 70V 1.3, 2.5, 5, 10, 20
- 100V 20, 10, 5, 2.5
- 100V 2.5, 5, 10, 20
- Installed Frequency Response: 48Hz - 24kHz
- Sensitivity: 89db
- Power Handling: In 8Ω Mode 5-120W
- Connector Type: Four-position Plug-in Screw Terminal
- Speaker Weight: 7.10lbs (3.22kg)
- Cutout: 8.4" (214mm)
- Diameter 9.4" (239mm)
- Depth 6.8" (172mm)
- EZBracket Size: F

## 8" IN CEILING

### **TIC801 70/100 Volt In Ceiling 8" 2 Way**

- In Ceiling 2 Way
- Woofer: 8" Fluted Injected Poly
- 1" Aluminum Dome Tweeter
- Butyl Rubber Surround
- Sonic Vortex® Ported Transmission Line Enclosure
- Magnetic Bezelless Grille; White - Paintable
- Low Impedance: 8Ω
- 25V 0.3, 0.5, 0.9, 1.8, 3.5
- 70V 1.9, 3.8, 7.5, 15, 30
- 100V 3.8, 7.5, 15, 30
- Installed Frequency Response: 35Hz - 24kHz
- Sensitivity: 92db
- Connector Type: Four-position Plug-in Screw Terminal
- Power Handling: In 8Ω Mode 5-120W
- Speaker Weight: 8.38 lbs (3.8kg)
- Cutout: 10.3" (261.5mm)
- Diameter 11.3" (284mm)
- Depth 8.6" (219.5mm)
- EZBracket Size: B

# Specifications

## 4" SHALLOW DEPTH IN CEILING/IN WALL

### **TICW401 70/100 VOLT In Ceiling/In Wall 4" 2 Way**

- In Wall or In Ceiling 2 Way
- Woofer : 4" Fluted Injected Poly
- ¾" Aluminum Dome Tweeter
- Butyl Rubber Surround
- Sonic Vortex® Ported Transmission Line Enclosure
- Magnetic Bezelless Grille; White - Paintable
- Low Impedance: 8Ω
- 25V 0.2, 0.3, 0.5, 0.9, 1.8
- 70V 1, 1.9, 3.8, 7.5, 15
- 100V Taps: 15, 7.5, 3.8, 1.9 Watts
- 100V 1.9, 3.8, 7.5, 15
- Installed Frequency Response: 68Hz - 24kHz
- Sensitivity: 89dB
- Connector Type: Four-position Plug-in Screw Terminal
- Power Handling: In 8Ω Mode 5-80W
- Speaker Weight: 2.59lbs (1.175kg)
- Cutout: " 6.4" (162mm)
- Diameter " 7.4" (186mm)
- Depth 3.82" (97mm)
- EZBracket Size: J

### **TU401 70/100 VOLT In Ceiling/In Wall 4" 2-Way Pancake**

- In Wall or In Ceiling 2 Way
- Woofer: 4" Fluted Injected Poly
- ¾" Aluminum Dome Tweeter
- Butyl Rubber Surround
- Sonic Vortex® Ported Transmission Line
- Magnetic Bezelless Grille; White - Paintable
- Low Impedance: 8Ω
- 25V 0.2, 0.3, 0.5, 0.9, 1.8
- 70V 1, 1.9, 3.8, 7.5, 15
- 100V Taps: 15, 7.5, 3.8, 1.9 Watts
- 100V 1.9, 3.8, 7.5, 15
- Installed Frequency Response: 62Hz - 24kHz
- Sensitivity: 88dB
- Connector Type: Four-position Plug-in Screw Terminal
- Power Handling: In 8Ω Mode 5-80W
- Speaker Weight: 2.93lbs (1.33kg)
- Cutout: " 8.4" (162mm)
- Diameter " 9.5" (241.4mm)
- Depth 2.76" (70.2mm)
- EZBracket Size: F

# Limited Lifetime Warranty

For Beale Street Audio Branded In-Wall and In-Ceiling Speakers and Subwoofers Purchased after May 1, 2017

## Limited Warranty

Vanco warrants to you, the original consumer purchaser of speakers, that under proper use and conditions, and subject to the other conditions provided below, your speakers will be free from defective materials and workmanship for the life of the speakers. This warranty only applies to passive speakers. Active products, such as amplifiers, electronics, and powered subwoofers are not covered under the Lifetime Warranty. Please review the individual manual provided with each specific product for the warranty information.

## What Vanco Will Do

If a speaker proves defective in either material or workmanship, Vanco, at its option, will either (a) repair and return it to you, or (b) replace and ship you a new speaker of the same model, unless your model is no longer available, in which case Vanco may replace your speaker with a current model of comparable value. In either case, Vanco will pay the shipping charge of sending you (US only) a replacement speaker or your repaired speaker. If a current model is substituted for your speaker, a modification to the mounting surface may be required. Vanco is not responsible or liable to make, account for or pay the cost of any such modification.

## How To Make A Warranty Claim

The first step in making a claim under this limited warranty is to contact the Vanco authorized distributor/dealer where you purchased the speaker, or if you are unable to contact the distributor/dealer, you can contact Vanco directly, for instructions on what action to take. If it is necessary to return the speaker, it must be shipped in appropriate packaging to the destination given to you, prepaid with signature required for delivery, and be accompanied by (1) a document providing your name, address, phone number and email address, and a statement of why you believe the speaker is defective, and (2) a copy of your original receipt or bill of sale that identifies you as the original purchaser of the speaker and the authorized distributor/dealer you purchased it from ("Proof of Purchase"). You have the risk of loss or damage in transit to the destination, and therefore you are responsible for insuring the shipment for the full value of the speaker. Freight collect shipments will be refused. If Vanco determines this limited warranty does not cover your claim, your speaker will be returned to you freight collect.

## Exclusions and Limitations

This limited warranty does not cover:

- > Speaker failure caused by anything other than a defect in material and workmanship.
- > Consequential damage to other components, equipment or premises regardless of the reason.
- > The cost of removing and reinstalling your speaker.
- > The cost of returning your speaker to Vanco.
- > Any claims if you are unable to provide Proof of Purchase from a Vanco authorized distributor/dealer.

Warranty continued next page

# Limited Lifetime Warranty (cont)

For Beale Street Audio Branded In-Wall and In-Ceiling Speakers and Subwoofers Purchased after May 1, 2017

## **This Limited Warranty Is Null And Void If Your Speaker:**

- > Was used in an application or environment other than that for which it was intended
- > Misused, abused, improperly installed or removed
- > Damaged by any accident, disaster or other cause not related to defects in materials and workmanship.
- > You sell or otherwise transfer your speaker to any other person.
- > Was modified or repaired by anyone other than Vanco, or its serial number is altered, defaced or removed.

REPAIR OR REPLACEMENT OF YOUR SPEAKER UNDER THIS WARRANTY IS YOUR EXCLUSIVE REMEDY. IN NO EVENT WILL VANCO BE LIABLE FOR ANY AMOUNT GREATER THAN THE ACTUAL PURCHASE PRICE PAID BY YOU FOR THE SPEAKER. VANCO SHALL NOT BE LIABLE FOR ANY FOR SPECIAL, INCIDENTAL, CONSEQUENTIAL, OR INDIRECT DAMAGES HOWSOEVER CAUSED. THIS LIMITED WARRANTY REPRESENTS THE ENTIRE WARRANTY AGREEMENT BETWEEN YOU AND VANCO REGARDING YOUR SPEAKERS AND IS GIVEN IN LIEU OF ALL OTHER WARRANTIES, EXPRESS OR IMPLIED, INCLUDING WITHOUT LIMITATION IMPLIED WARRANTIES OF MERCHANTABILITY AND FITNESS FOR A PARTICULAR PURPOSE. THIS WARRANTY GIVES YOU SPECIFIC LEGAL RIGHTS AND YOU MAY ALSO HAVE OTHER RIGHTS THAT VARY, FROM STATE TO STATE. SOME STATES LIMIT WHAT WARRANTIES MAY BE EXCLUDED AS WELL AS HOW LONG AN IMPLIED WARRANTY LASTS, SO THESE LIMITATIONS MAY NOT APPLY TO YOU.

The Vanco logo, Sonic Vortex logo, and Beale Street Audio Inc. logo are registered trademarks of Vanco International, LLC.

Vanco, Sonic Vortex, Beale Street Audio, Get Reale. Get Beale., the Vortex logo, and the Beale Street Audio logo are trademarks of Vanco International, LLC.



Get Reale. Get Beale.™



A NEW BRAND FROM  **VANCO.**

Vanco International, LLC  
506 Kingsland Drive  
Batavia, IL 60510

Phone: 800.626.6445 Fax: 630.879.9189

[www.getbeale.com](http://www.getbeale.com)

©2017